



LASER MARKING

VLASE SERIES: LASER MARKING MADE EASY

VLASE Series is a Solid State, Laser Marking product Family dedicated to General Manufacturing, Electronics, Automotive and Aerospace industry for Direct Part Marking on high reflectivity materials, heat sensitive parts and high stability thermoplastic components.

Based on our consolidated Solid State resonator architecture VLASE Series is available in a variety of different power levels and in three wavelengths to cover a wide range of application types and materials, even on hard-to-mark materials.

APPLICATIONS

Automotive

- Coating removal and Paint stripping for NIGH & DAY application
- High Contrast DPM for traceability, Quality Control, Testing & Sorting on high reflectivity materials.

Electronics

- DPM for traceability to thermal sensitive, like silicon wafers,
- WLCSP, memory cards, ICs or high reflectivity materials like copper, gold and silver
- Branding and high resolution product identification



Quick Installation and Setup

VLASE Series of solid state laser markers combines a state-of-the-art Solid State laser source with a high flexibility and easy setup embedded controller, providing to machine builders, system integrators and end users a compact, full features controller, with embedded 100-240 VAC power supply, diode module, TEC cooler, and drivers.

- Embedded controller with Windows Embedded Standard 7 Operative System, full language support and dedicated Solid State Hard Disk for data storage.
- Embedded 90-240 VAC power supply.
- embedded 4 independent step motors controller dramatically simplifies management of rotary indexers, x-y tables, z axis etc

- I/O connections, fiber delivery and IEC power inlet are located on back panel for easy integration, as well as dedicated M12 connectors for Photocell and Encoder.
- Front panel now offer main laser commands key and enable, USB port an new improved air cooling system with removable dust filter, that enhance operative temperature range up to 40°C @ full power.
- Simplified access to Laser Diode Module for fiber installation and maintenance
- Fail-Safe, redundant interlock system, fully compliant with EN 60825.1
- Completely sealed, bending free, long lifetime laser diode module.
- Full on screen diagnostic.

Flexible programming control

LIGHTER Suite, with its Intuitive and easy-to-learn interface, simplifies the development of a complete and cost effective Laser Marking Station for OEM and Machine builders.

VLASE Series is thought to be used in both a STAND ALONE MODE with built-in control and software resources, and in a MASTER-SLAVE mode with a with supervising computer for advanced network-oriented Laser Marking Applications.

Main VLASE Series features are:

- Advanced Graphical Layout
- Local and Remote laser diagnostic
- Local and Remote I/O & axis control
- Local and Remote laser test & setup
- Local and Remote ActiveX
- Ethernet protocol for easy integration in PLC and industrial environments
- Marking On Fly capabilities

VLASE SERIES

	VLASE IR 10	VLASE IR 15	VLASE IR 20	VLASE GREEN 10	VLASE UV 3
Wavelength [nm]	1064	1064	1064	532	355
Nominal Power [W]	10	15	20	10	3
Repetition Rate Range [KHz]	10 ÷ 100	15 ÷ 200	20 ÷ 200	20 ÷ 100	20 ÷ 80
Pulse Width [ns]	15@10KHz	12@15KHz	8@20KHz	10@50KHz	8@25KHz
Max Pulse Energy [mJ]	0.48@10kHz	0.65@15kHz	0.55@20kHz	0.31@20kHz	0.12@30kHz
Peak power [kW]	32@10kHz	55@15kHz	65@20kHz	28@20kHz	14@25kHz
Marking capabilities	Standing, Rotary axis, On the fly (marking in motion)				
integration	Up to 4 mechanical axis driving capabilities (stepper motor) Up to 10 digital inputs and 10 digital output fully programmable dedicated connectors Encoder and Photocell				
Interface	Ethernet, RS 232, USB				
Optical Fiber	Detachable – 3 meters standard- 5 meters OPT				
Aiming Beam	Semiconductor Laser – 630 – 670 nm				
Power Supply	100- 240 VAC 50/60Hz – 600 W max				
Cooling System	Air cooled				
Temperature Range	5°C to 40°C (41°F to 104°F)				

All laser sources described in this product guide are Class 4 laser sources.

Laser interaction with organic or inorganic material can cause TOXIC FUMES/PARTICLES. The OEM laser components described in this product guide is for sale solely to qualified manufacturers, who shall provide interlocks, indicators and other appropriate safety features in full compliance with applicable national and local regulations

VLASE SERIES (WAVELENGTH)

New VLASE Family is available in three wavelength to satisfy all a wide range of application types and materials, where high peak power, short pulse width and high beam quality is required.

VL-IR (Infrared)	VL – GREEN	VL – UV (Ultra Violet)
DPSS Laser markers @ 1064 nm	DPSS Laser markers @ 532nm	DPSS Laser marker @ 355 nm
High peak power, short pulse Infrared laser markers available in 10, 15 and 20W power level.	High peak power, high efficiency, intracavity SHG (second harmonic Generation) laser markers available in tow power size: 4W and 10W	High peak power, low lifetime, THG (Third Harmonic Generation) laser marking product with emission @ 355 nm

APPLICATIONS

Excellent beam quality, VL-IR is the general purpose laser marker for wide range of materials.

High peak power and short pulse width ensures low thermal footprint and reduced HAZ (Heat Affected Zone) assures stable and precise marking on non additivated thermoplastic polymers (such as ABS, PP, PES, PET, PVC), on coated materials or low absorption materials



Night & Day

Automotive dashboard pushbutton, black painted.
Accurate coating removal without any damage of the bulk structure



Faucets Marking –

Nickel coated Solid Brass
Accurate color change of nickel coating, nickel protective coating is not removed.

Green emission laser offers significant advantages in marking applications with materials such as plastics that do not interact with the infrared wavelength, as well as with semiconductors such as silicon (e.g. wafer marking) or high reflectivity metals like copper, gold & silver.



High contrast marking on high reflectivity materials, Copper



High resolutions marking on high reflectivity materials, brass

Excellent marking quality, very fine spot size, for "cold marking" application, with very low thermal footprint for ablative damage free marking applications on various materials, including sapphire, glass, diamond, silicone, PE, HDPE (high Density Polyethylene), ceramic, alumina, and other sensitive materials.



HDPE Marking

High contrast marking on high stability materials, HDPE for medical application and devices.



Glass Marking

Cracks free glass marking and engraving

DIMENSIONS

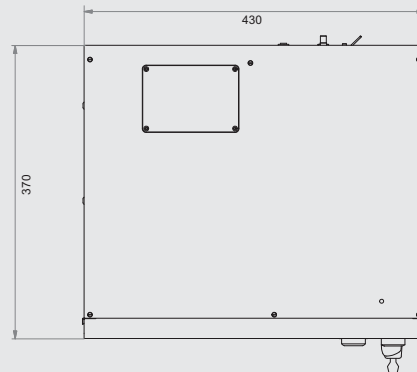
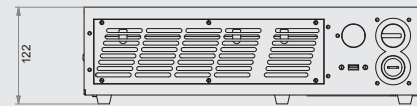
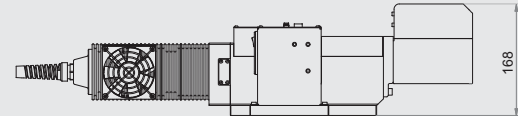
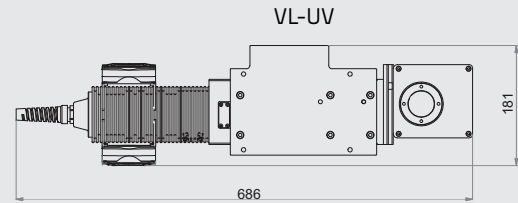
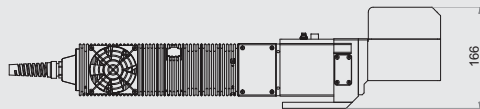
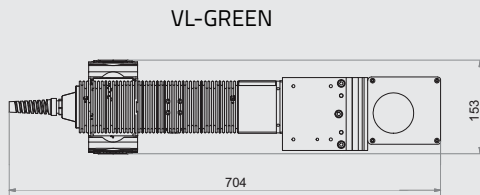
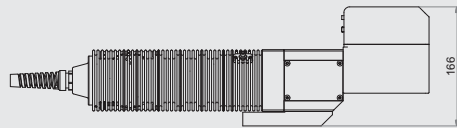
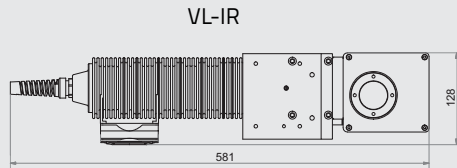

MODEL SELECTION AND ORDER INFORMATION

VLASE IR10

985110038	VLASE 1109-1042 DPSS IR System	NEW VLASE - IR10: 1064 Solid State Marker 10W w/out F-theta
985110039	VLASE 1109-1342 DPSS IR System	NEW VLASE - IR10: 1064 Solid State Marker 10W with F160S-M39
985110052	VLASE 1109-1642 DPSS IR System	NEW VLASE - IR10: 1064 Solid State Marker 10W with F254S-M39
985110040	VLASE 1109-1442 DPSS IR System	NEW VLASE - IR10: 1064 Solid State Marker 10W with F160L-M85
985110057	VLASE 1109-1742 DPSS IR System	NEW VLASE - IR10: 1064 Solid State Marker 10W with F254L-M85

VLASE IR15

985110041	VLASE 1159-1042 DPSS IR System	NEW VLASE - IR15: 1064 Solid State Marker 15W w/out F-theta
985110042	VLASE 1159-1342 DPSS IR System	NEW VLASE - IR15: 1064 Solid State Marker 15W with F160S-M39
985110053	VLASE 1159-1642 DPSS IR System	NEW VLASE - IR15: 1064 Solid State Marker 15W with F254S-M39
985110043	VLASE 1159-1442 DPSS IR System	NEW VLASE - IR15: 1064 Solid State Marker 15W with F160L-M85
985110058	VLASE 1159-1742 DPSS IR System	NEW VLASE - IR15: 1064 Solid State Marker 15W with F254L-M85

VLASE IR20

985110036	VLASE 1209-1042 DPSS IR System	NEW VLASE - IR20: 1064 Solid State Marker 20W w/out F-theta
985110044	VLASE 1209-1342 DPSS IR System	NEW VLASE - IR20: 1064 Solid State Marker 20W with F160S-M39
985110054	VLASE 1209-1642 DPSS IR System	NEW VLASE - IR20: 1064 Solid State Marker 20W with F254S-M39
985110045	VLASE 1209-1442 DPSS IR System	NEW VLASE - IR20: 1064 Solid State Marker 20W with F160L-M85
985110059	VLASE 1209-1742 DPSS IR System	NEW VLASE - IR20: 1064 Solid State Marker 20W with F254L-M85
985110060	VLASE 1209-1A42 DPSS IR System	NEW VLASE - IR20: 1064 Solid State Marker 20W with F 330L-M85
985110061	VLASE 1209-1B42 DPSS IR System	NEW VLASE - IR20: 1064 Solid State Marker 20W with F 420L-M85

VLASE UV3

985110050	VLASE 3039-1042 DPSS UV System	NEW VLASE - UV 3 Solid State Marker w/out F-theta
985110051	VLASE 3039-1842 DPSS UV System	NEW VLASE - UV 3 Solid State Marker with F= 103 Telecentric
985110056	VLASE 3039-1442 DPSS UV System	NEW VLASE - UV 3 Solid State Marker with F160L-M85

