

Vision Made Simple

The power of AI without the complexity

IN-SIGHT 2800 SERIES



COGNEX

IN-SIGHT 2800 SERIES

Automate error detection in minutes—
no experience needed

The In-Sight® 2800 series vision system combines artificial intelligence (AI) technology with traditional rule-based vision tools to solve a wide range of inspection applications. From presence/absence detection to sortation and character reading, In-Sight 2800 provides an easy to deploy solution for error-proofing tasks. Designed for factory automation, In-Sight 2800 enables manufacturers of all size to:

- Increase product quality
- Maximize operational efficiency
- Streamline integration



Increase product quality

Catch subtle defects, classify parts with variation, and decipher complex text with highly accurate, AI-based error detection and character reading.

AI and rule-based vision tools



LEARN MORE
PAGE 4

Powerful classification and OCR functionality



LEARN MORE
PAGE 4

OK/NG

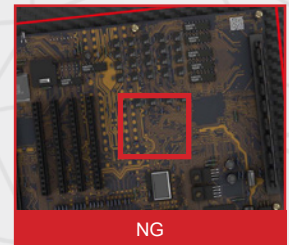
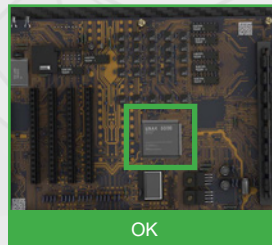
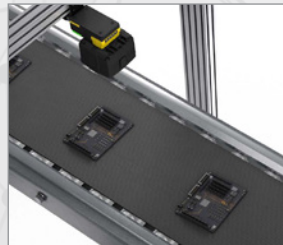

Categorize types of defects

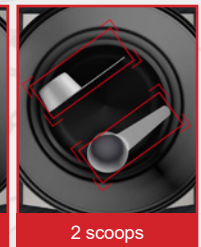
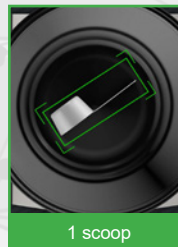

OCR

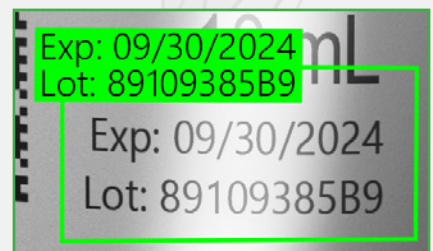

Maximize operational efficiency

Leverage your existing workforce and keep your lines running with fast, intuitive job setup—no vision or AI expertise required.

Intuitive development environment



Step-by-step guidance



Setup Image



Inspect Part



Run HMI

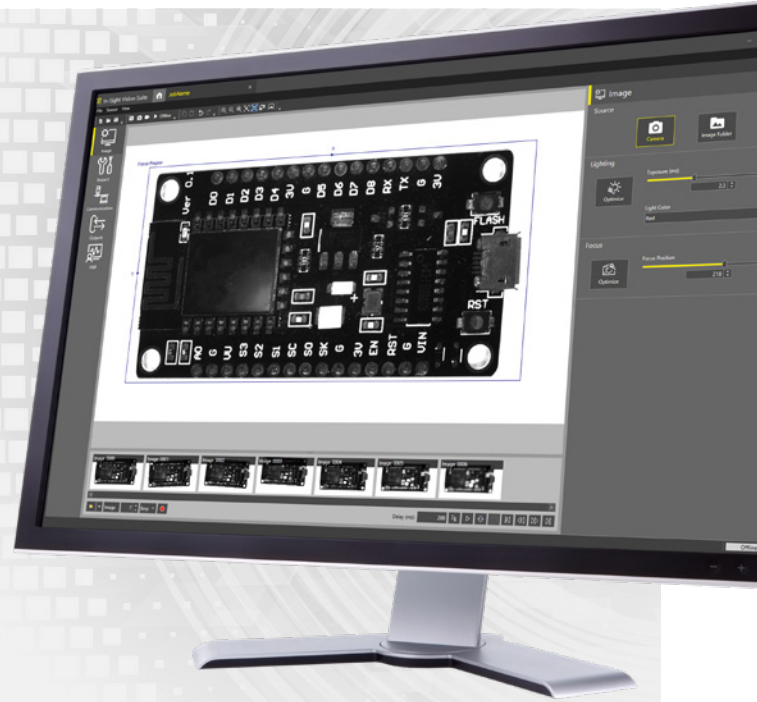

2-click image setup

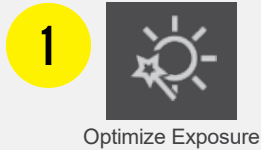
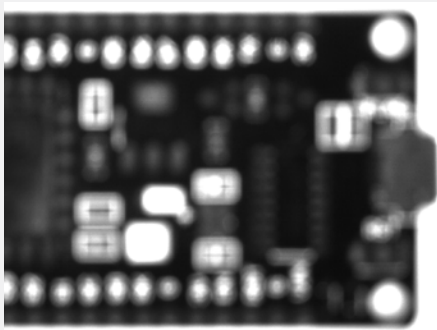

Optimize Exposure

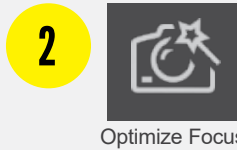

Optimize Focus

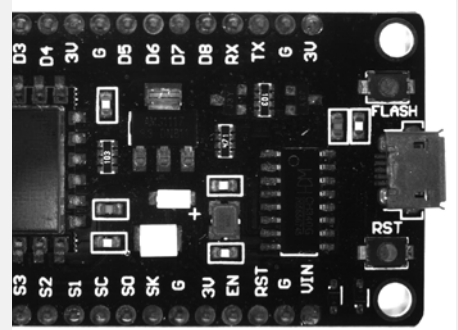

Streamline integration

Modular solutions for integrated lights and lenses takes the guesswork out of image optimization. Identifying the correct combination of accessories for your application is only a few button clicks away.

Integrated multi-color lighting



Compact, modular design



Comprehensive vision toolset addresses tasks of varying complexity

Integrating AI and rule-based tools in a single vision system, the In-Sight 2800 series solves a variety of error-proofing applications. Use the tools individually for simple jobs or chain them together to solve more complex logic sequences.



AI tools

The In-Sight 2800 is embedded with powerful edge learning tools that leverage AI technology to process images on device, or “at the edge” of where the data originates, delivering accurate results in real time.



ViDi EL Classify

Go beyond the standard OK/NG output with ViDi™ EL Classify. The tool identifies and sorts parts based on multiple features or characteristics. This enables users to classify defects into different categories and correctly identify parts with variation, allowing them to automate a wider range of tasks.

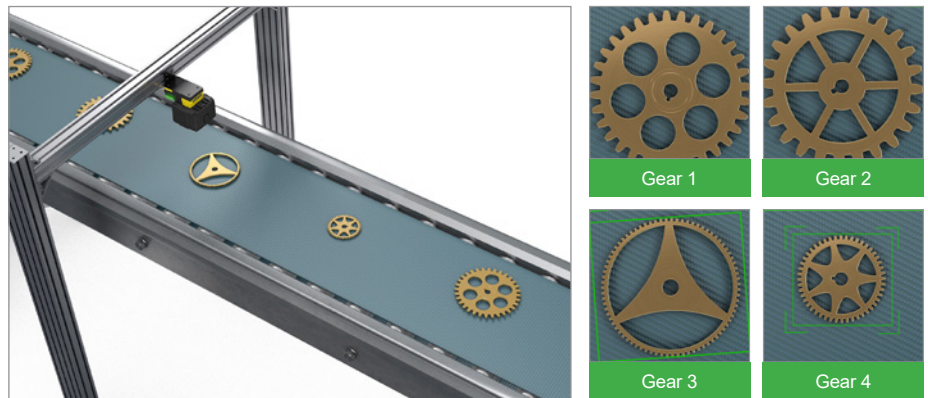

Training

ViDi EL Classify can be trained in minutes, using as few as five to ten images per class.



Confidence score

Get real-time, visual feedback on the accuracy of your results. The confidence score confirms whether the AI model correctly predicted the application output, leading to less manual intervention and more reliable inspections.

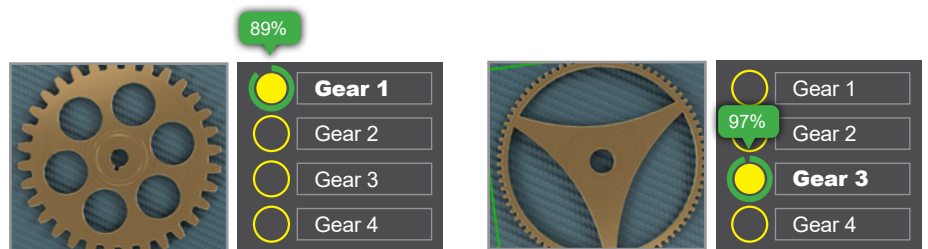



ViDi EL Read

Read characters on reflective, low-contrast, and non-flat surfaces with ease.

The ViDi EL Read tool deciphers a range of text, including multi-line text, using advanced optical character recognition (OCR). With minimal training required, the tool simplifies job setup and delivers fast, accurate character reading.

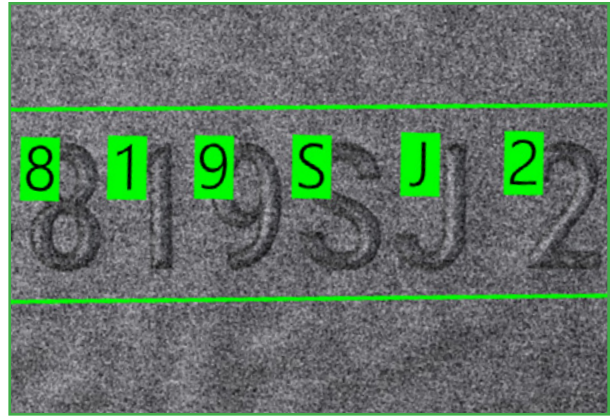
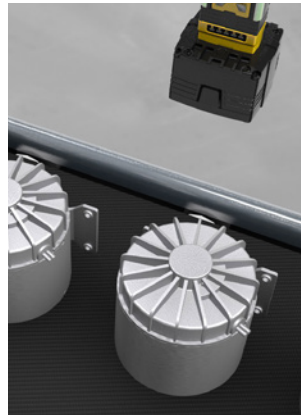

Training

Using a few example images of the relevant characters, ViDi EL Read can be setup and deployed in minutes.

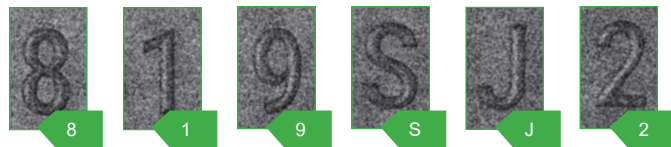

Confidence score

Assess the accuracy of your results with the confidence score displayed below each of the trained characters.

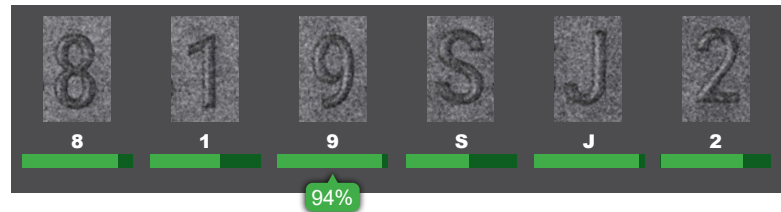

Rule-based vision tools

The In-Sight 2800 is also equipped with an extensive library of industry-proven traditional vision tools and algorithms including: Measure Distance, Pixel Count, Count Patterns, Math and Logic Tools, and much more.



Multiple regions of interest functionality

Set up multiple regions of interest (ROIs) to inspect different sections of your image with a single trigger.

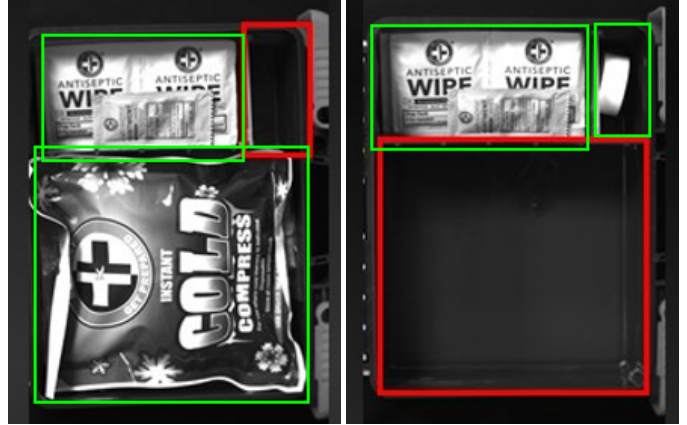
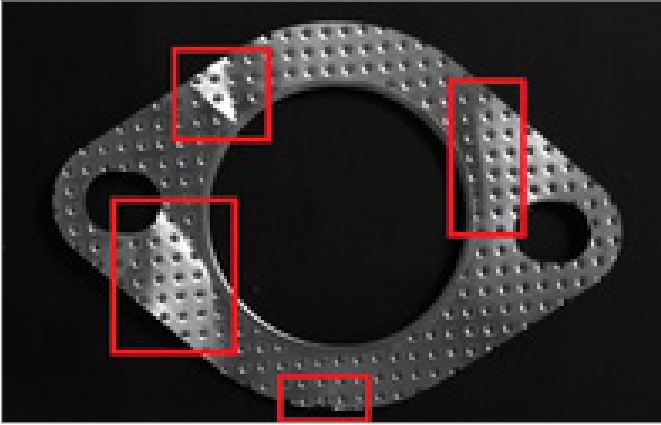

Classification application examples

Inspect cap seating

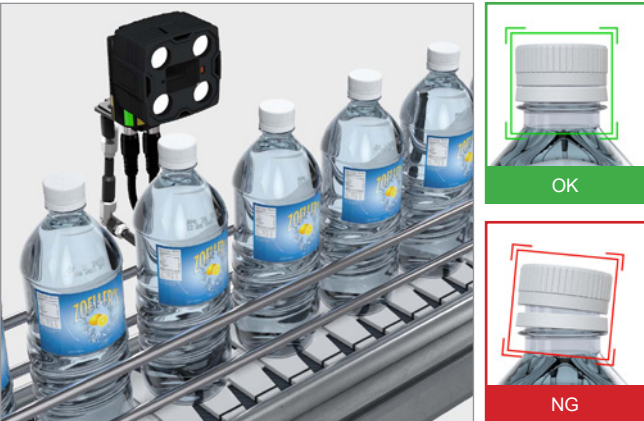

Detect presence/absence of serving scoops



Check assembly of packaged products

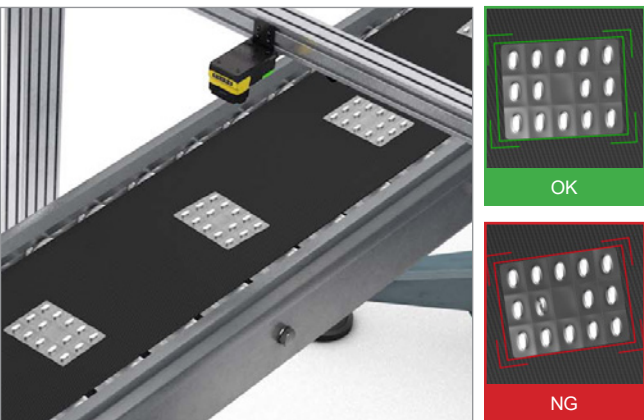

Inspect PCB components

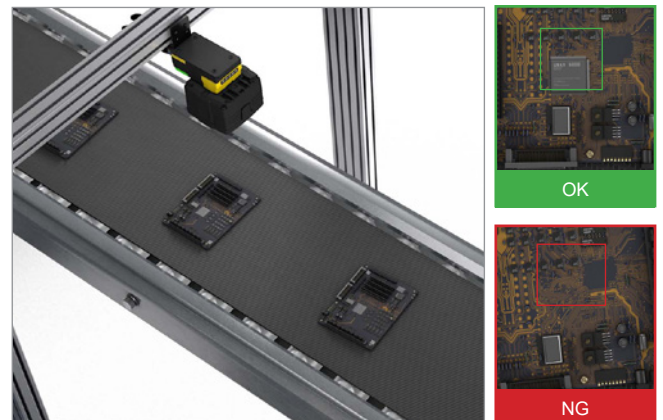

Verify proper insertion of components

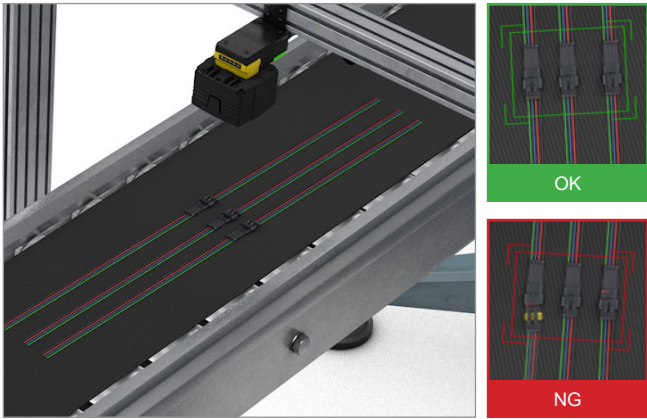

Detect and classify defects on product labels



Detect presence/absence of sealing caps

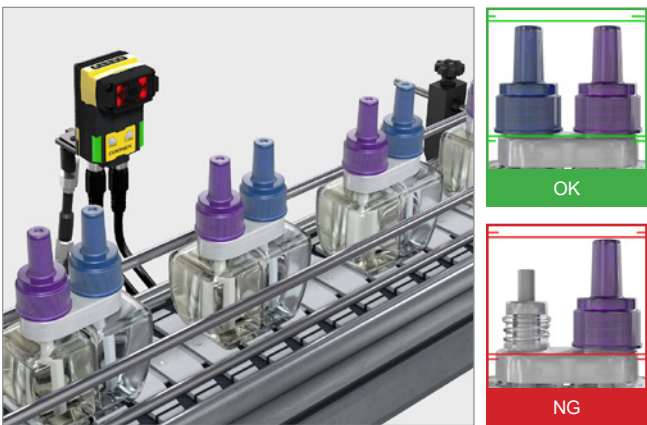

Inspect for mechanical defects

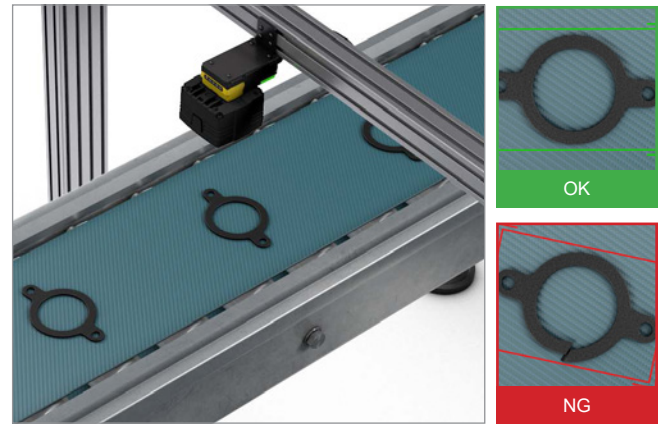

Classify scents or flavoring on packaging

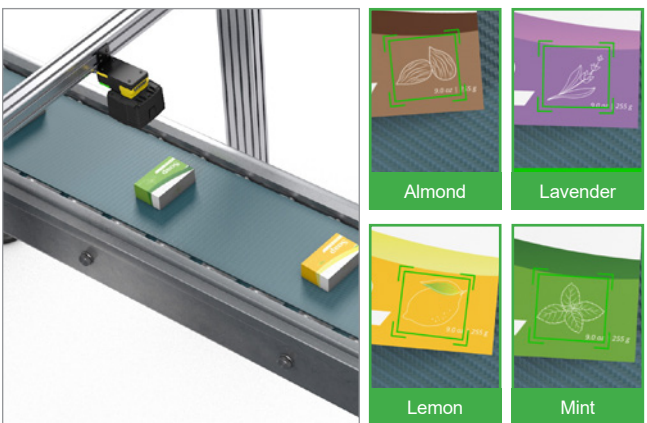

Check for missing components in final assembly

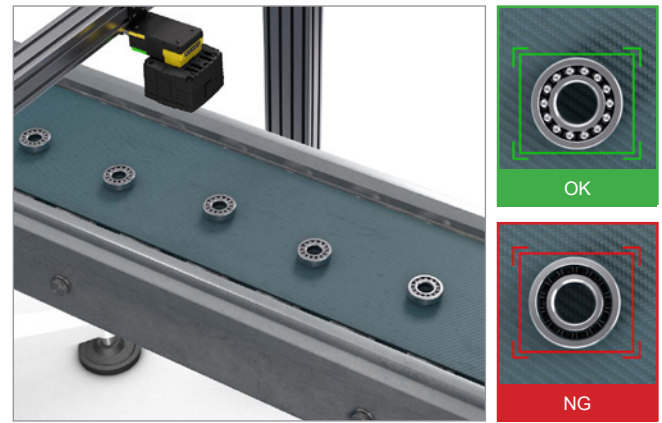



OCR application examples

Read text on curved surfaces



Read text on printed labels



Read dates and lot codes on reflective surfaces



Decipher characters against low-contrast backgrounds

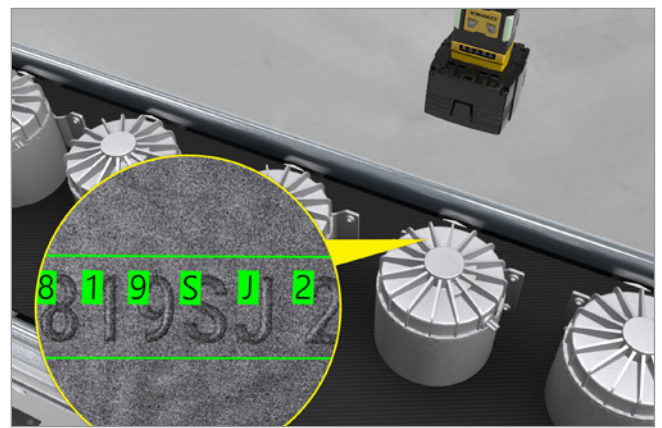

Read multiple lines of text at the same time



Common software platform offers flexible development options

In-Sight Vision Suite software is common across all In-Sight products and includes two programming environments — EasyBuilder® and spreadsheet — which allows you to seamlessly scale your solution as your business needs evolve.

EasyBuilder development environment simplifies setup and delivers rapid turnaround

With its point-and-click programming, the EasyBuilder interface within In-Sight Vision Suite is ideal for developing jobs, from simple to complex. The intuitive process guides developers step-by-step through setup—from image capture to the final result and beyond—allowing both new and experienced users to configure vision applications.

Easy **step-by-step** application setup

Image-centric **point-and-click** functionality allows users to quickly set up tools

Capture images live or upload existing images

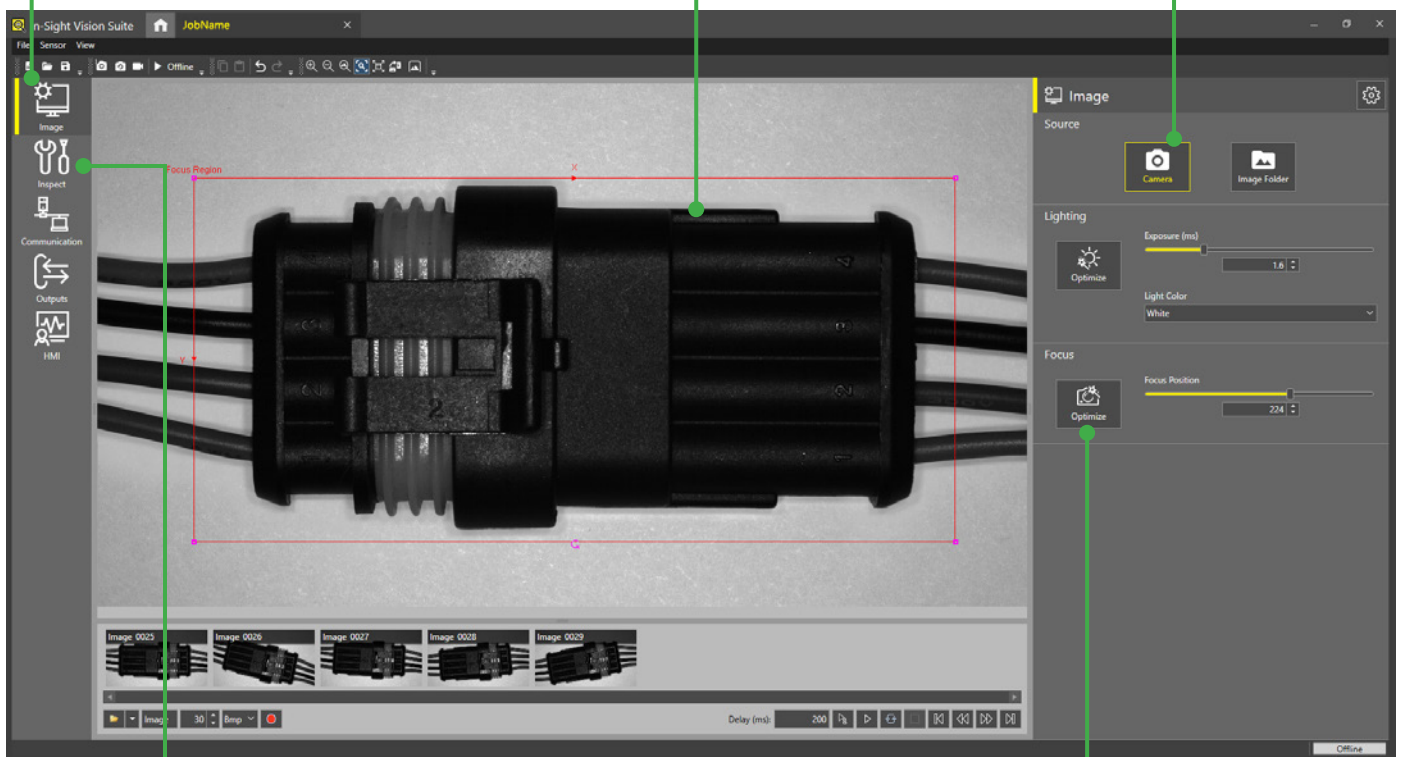

Comprehensive set of traditional rule-based vision tools and **innovative edge learning tools**

Fast, **2-click** image formation

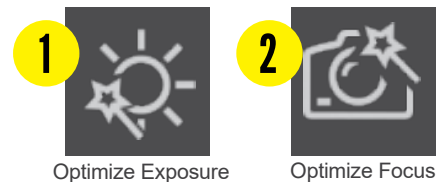

Spreadsheet guides users through advanced applications*

The In-Sight spreadsheet interface allows you to quickly set up and run jobs without the need for programming. This robust development environment provides you with the flexibility to make critical adjustments to job parameters, so you can adapt your applications as your requirements change.

Powerful **spreadsheet** interface allows users to solve complex applications

	A	B	C	D	E	F	G	H	I
0	<input type="checkbox"/> Image								
1									
2	PatMax								
3	<input type="checkbox"/> Patterns	1.000							
4		Index	X	Y	Angle	Scale	Score		
5	<input type="checkbox"/> Patterns	0.000	564.451	342.308	0.069	100.000	59.819		
6									
7	VIDI EL Classify								
8		Health	Num Class	Index	Label	Num Image	Score		
9	<input type="checkbox"/> VIDI EL Classify	99.882	5.000	0.000	Blueberry	8.000	98.949	<input checked="" type="checkbox"/> Collect Samples	
10				1.000	Damaged	5.000	0.373		
11				2.000	Lemon	6.000	0.369		
12				3.000	Strawberry	6.000	0.309		
13				4.000	Missing	6.000	0.000		
14					Unlabeled	0.000			
15									

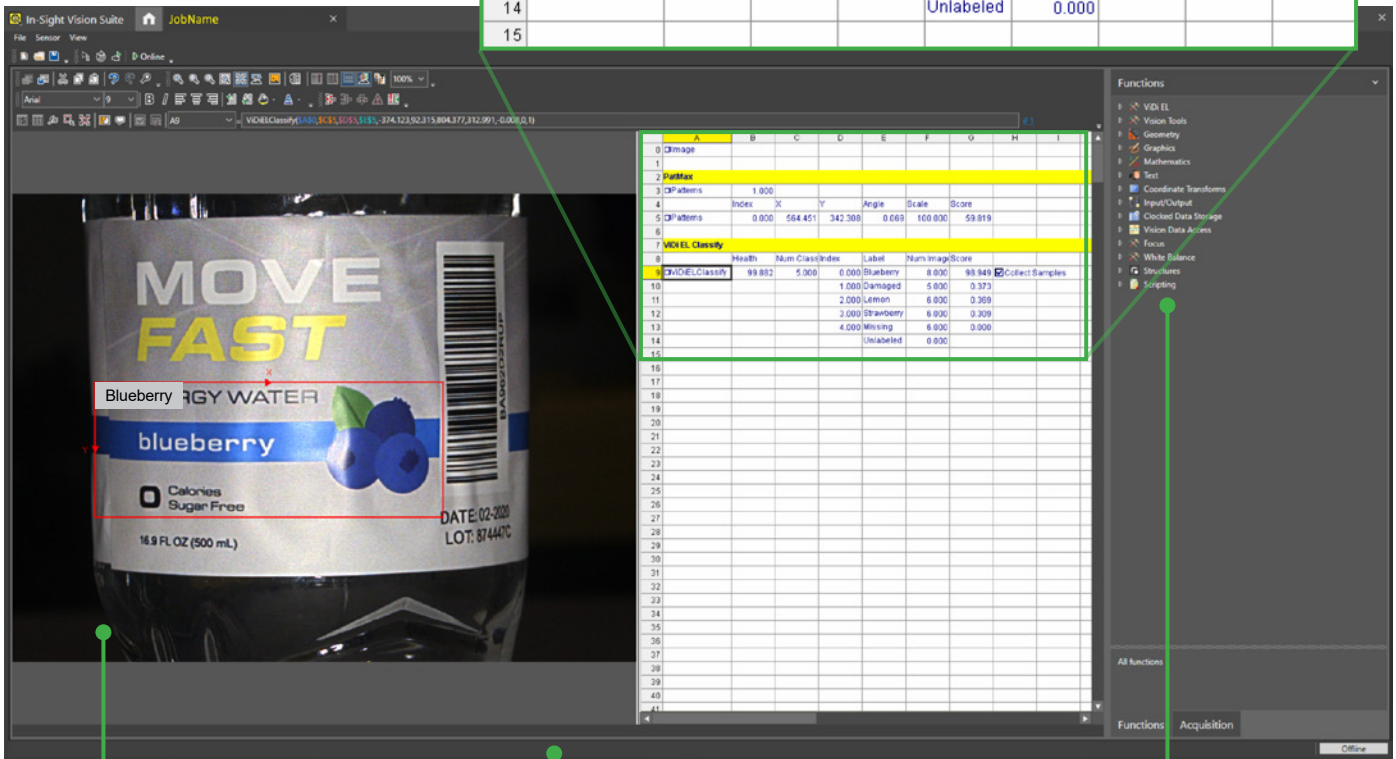

Easily review and recall files with image playback

Full I/O and communications function set streamlines factory integration

Full suite of AI- and rule-based vision tools

*Spreadsheet only available on In-Sight 2802 models.

Web-based HMI offers real-time application testing and optimization

The In-Sight 2800 series provides access to a web-based human-machine interface (HMI) that enables runtime visualization. From the HMI, users can view inspection results and modify setup parameters to optimize their application.

EasyView displays tags from jobs in a simplified format

The EasyView interface features a central camera view of a blue PCB with a green 'OK' tag in the top-left corner. To the right is a parameter panel with the following fields: 'Classify Tool' (OK), 'Classify Confidence' (89.831), 'Edit Classify Region' (Region), and 'OK/NG Threshold' (70). Further right is a control panel with a green 'Online' status indicator, 'Load' and 'Save' buttons, 'Online' and 'Offline' buttons, 'Trigger', 'Live Mode', 'Switch View', and 'Settings' buttons.

Online/Offline status indicator

Control panel allows users to manage the device through the web HMI

CustomView shows advanced settings from the spreadsheet*

Overlay graphics clearly display application output

The CustomView interface features a central camera view of a blue PCB with a detailed 'MDI EL Classify' overlay. The overlay includes: 'Tool Status' (OK), 'Confidence Score' (89.831), and 'Confidence Threshold' (70). To the right is a control panel with a green 'Online' status indicator, 'Load' and 'Save' buttons, 'Online' and 'Offline' buttons, 'Trigger', 'Live Mode', 'Switch View', and 'Settings' buttons.

*CustomView only available on In-Sight 2802 models while using the spreadsheet interface.

Full-featured vision system solves broad range of applications

The In-Sight 2800 is engineered with the entire suite of powerful Cognex vision tools and convenient features to automate applications easily and reliably.

SVGA, 1.6 MP, and 2 MP sensor options offer greater detail in smaller parts and larger field of view coverage

Field-interchangeable optical accessories increase flexibility to solve variable applications

Compact form factor with **straight or right-angle configuration**

Multi-core processor enables fast acquisition

Indicator lights for operator feedback

Gigabit Ethernet delivers fast communication speeds and image offload

Powered by 24V

Powerful and flexible integrated lighting

Multi-color (RGBW) lighting option allows you to optimize image contrast for the application, regardless of operating conditions. Simply click a button in In-Sight Vision Suite to change the light color.



Actual part



Red light:
Numbers are unclear



Blue light:
Numbers are clear



Powerful imaging technology delivers improved inspection accuracy

High Dynamic Range (HDR) Technology uses advanced image sensor technology that is 16X more detailed than conventional sensors. This drastically increases image quality and contrast, resulting in more accurate inspections and detection of even the most subtle defects.

Part inspection

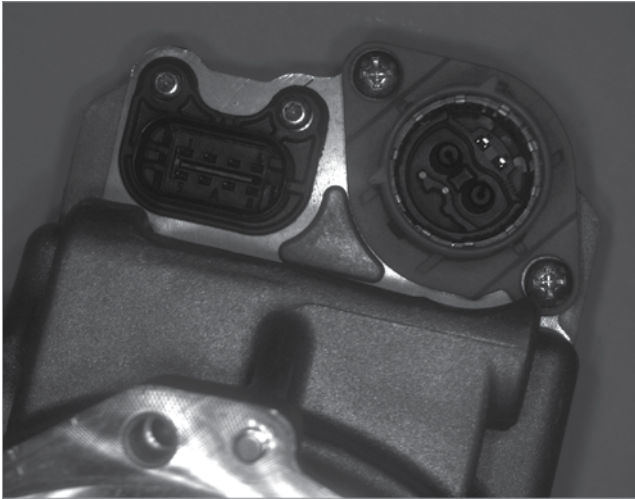

Without HDR: Inset features are unclear.

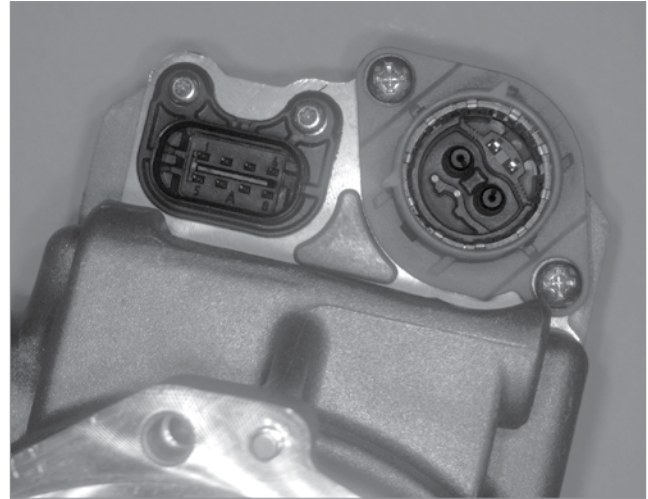

With HDR: All features are visible.

Greater depth-of-field

HDR reduces over- and under-exposure, providing greater depth-of-field than conventional imaging sensors.

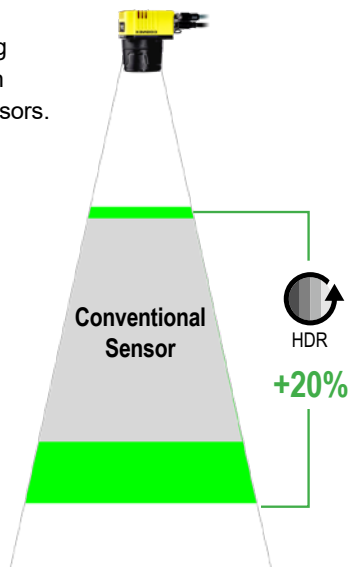

Faster line speeds

HDR reduces exposure times, enabling you to accommodate faster line speeds.

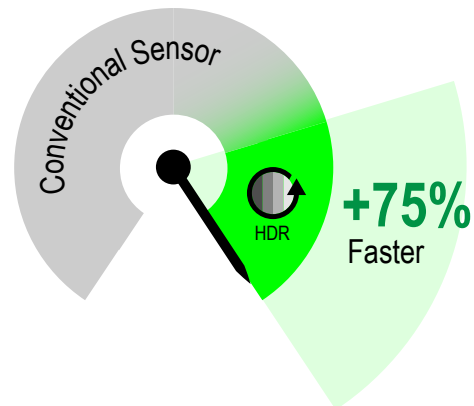

Modular, scalable architecture for current and future needs

The In-Sight 2800 series offers a wide variety of accessories and field-changeable components. This flexibility enables manufacturers to quickly adapt to new parts and keep up with changing demands, such as part changes, faster line speeds, and higher quality standards.

In-Sight 2800 Series with Multi Torch

High Speed Liquid Lens (HSSL) allows for fast image setup and focusing on-the-fly

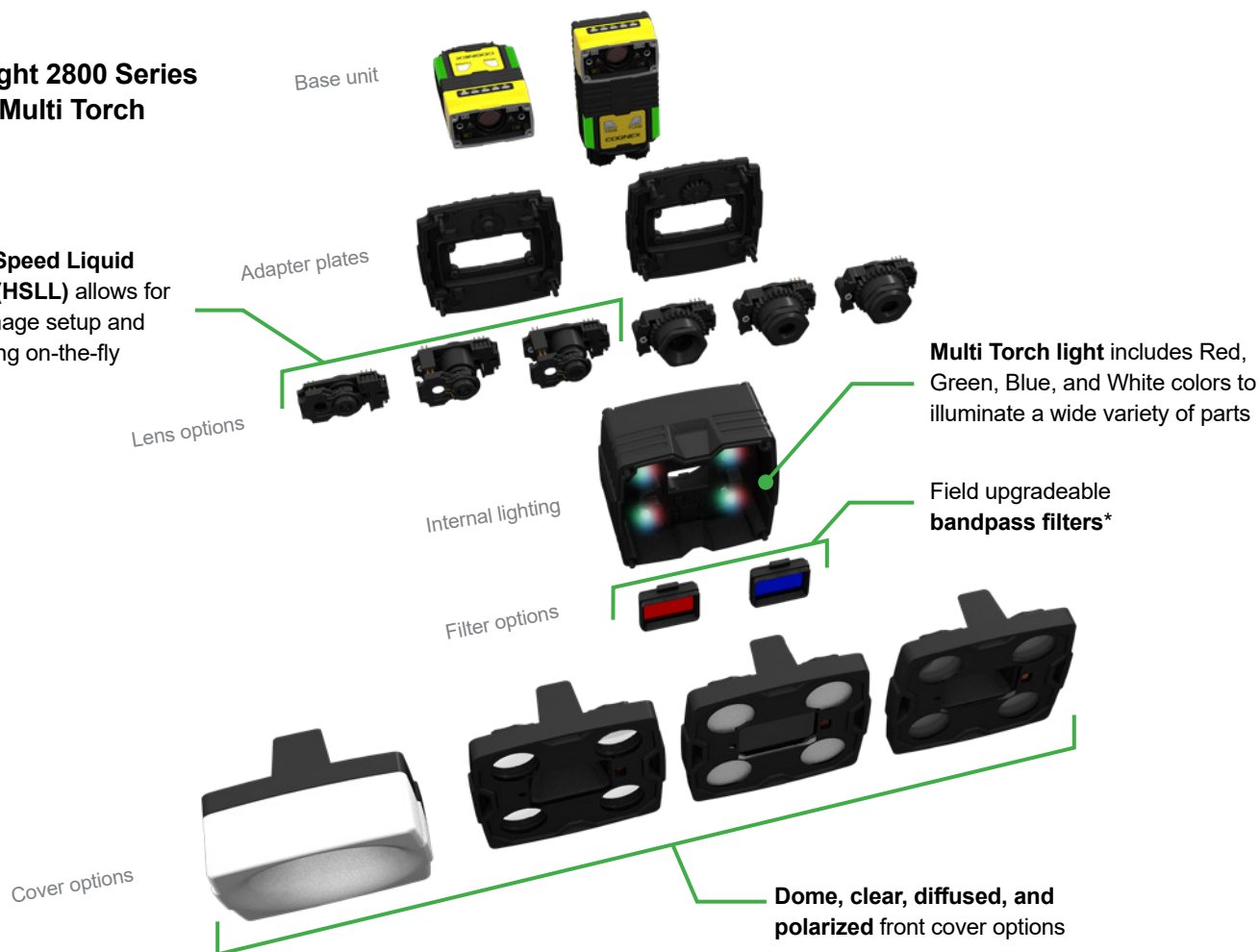

In-Sight 2800 Series with Mini Lights

High Speed Liquid Lens (HSSL) allows for fast image setup and focusing on-the-fly

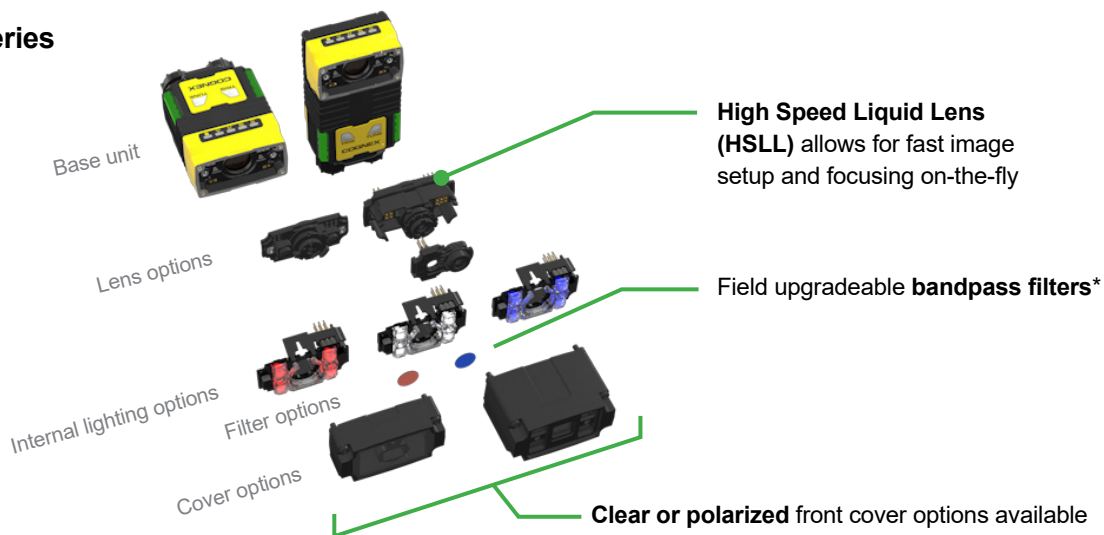

*Sold separately

IN-SIGHT 2800 SERIES SPECIFICATIONS

	In-Sight 2800	In-Sight 2801	In-Sight 2802
Image Sensor	1 1/2.8" CMOS monochrome and color		
Image Sensor Properties	6.17 mm diagonal, 2.8 μm square pixels		
Image Resolution Options	SVGA ¹ (720x540)	1.6 MP (1440x1080)	2 MP (1920x1080)
Electronic Shutter Speed	Min. exposure: 29 μs Max. exposure: Up to 10 ms (internal illumination) / Up to 200 ms (external illumination)		
Acquisition	Up to 45 Hz		
Lens Options	Multi Torch: 8 mm, 12 mm, 16 mm (High Speed Liquid Lens or manual focus lens) Mini: 6.2 mm or 16 mm High Speed Liquid Lens	Multi Torch: 12 mm, 16 mm (High Speed Liquid Lens or manual focus lens)	
Discrete Inputs	2 opto-isolated		
Discrete Outputs	2 opto-isolated		
Other I/O Points	2 user configurable as inputs or outputs		
Status Outputs	5 status LEDs, audible beeper		
Lighting	Multi Torch: High-Powered Multi-Color 4 LED ring light (red, green, blue, white) Mini: 4 LED small form factor light for 6.2mm lens (red, blue, white, IR options) Mini HPIL: 4 LED small form factor high-powered light for 16 mm lens (red, white options)	Multi Torch: High-Powered Multi-Color 4 LED ring light (red, green, blue, white)	
Communications	Ethernet interface		
Protocols	TCP/IP, PROFINET, EtherNet/IP™, SLMP, OPC/UA, FTP		
Power	24V +/- 10%		
Power Consumption	≤7.5W		
Materials	ABS, acrylic, aluminum alloy, NBR, PC, PET, PMMA, silicone, silicone rubber, stainless steel, TVP, zinc alloy		
Weight	6.2 mm: 141 g; 16 mm: 169 g; Multi Torch: 290 g; Right angle configuration adds 50 g		
Operating Temperature	0–40 °C (32–104 °F)		
Storage Temperature	-10–60 °C (14–140 °F)		
Operating and Storage Humidity	<95% non-condensing		
Protection	IP67		
RoHS Certified	Yes		
Approvals	EU CE, US FCC, TUV CB NRTL IEC 61010		
Software	In-Sight Vision Suite		
In-Sight EasyBuilder access	✓	✓	✓
In-Sight spreadsheet access			✓

¹ SVGA options are monochrome only.

Field of view diagrams

In-Sight 2802 with Multi Torch

Working distances
Units: mm (*in*)

Minimum
50 (1.97)

Midpoint
300 (11.8)

Maximum
500 (19.69)

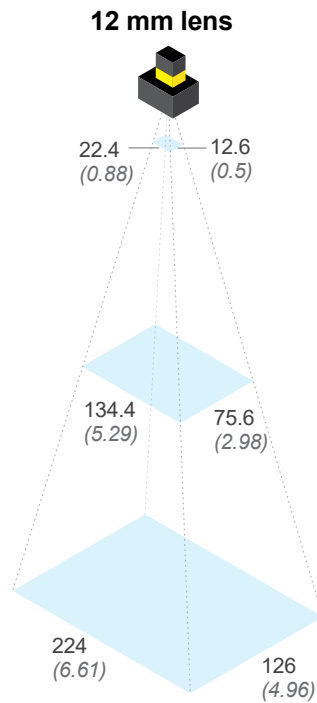

16 mm lens

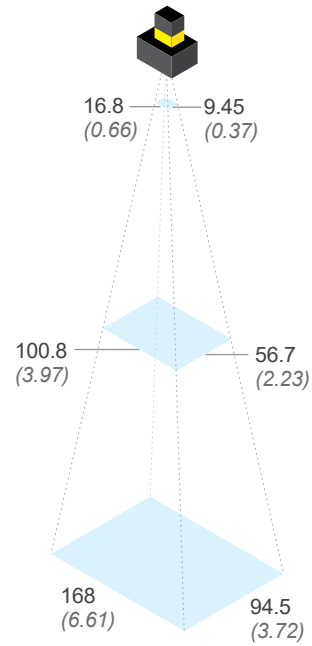

In-Sight 2800/2801 with Multi Torch

Working distances
Units: mm (*in*)

Minimum
50 (1.97)

Midpoint
300 (11.8)

Maximum
500 (19.69)

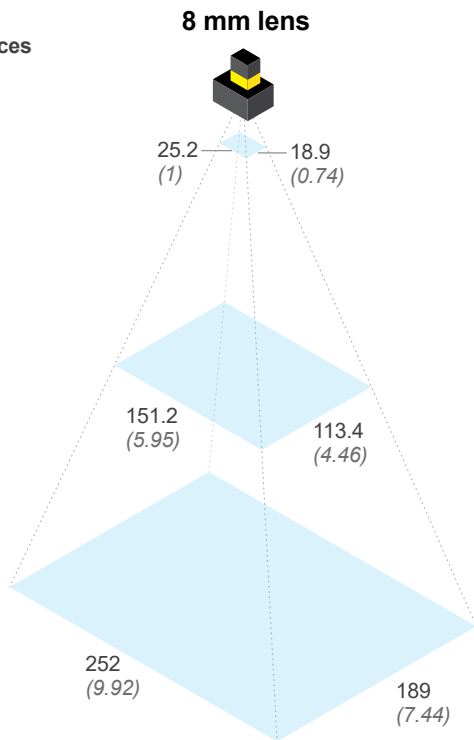

12 mm lens

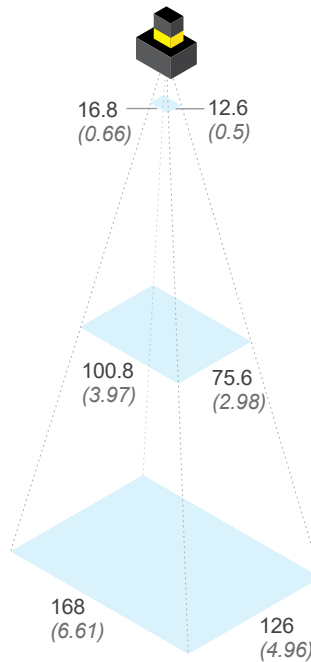

16 mm lens

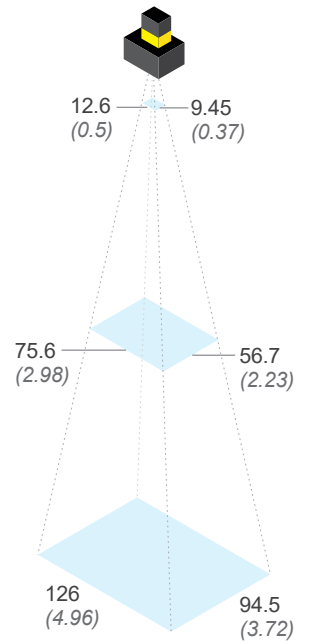

Focus distances

Minimum 50 mm (1.97) **Maximum** 2000 mm* (78.74)

*Applications with working distances beyond 500 mm may result in an in-focus image but light uniformity/intensity will be significantly lower. External lighting is recommended for these scenarios.

In-Sight 2800/2801 Mini

Working distances

Units: mm (in)

Minimum
50 (1.97)

Midpoint
300 (11.8)

Maximum
500 (19.69)

6.2 mm lens

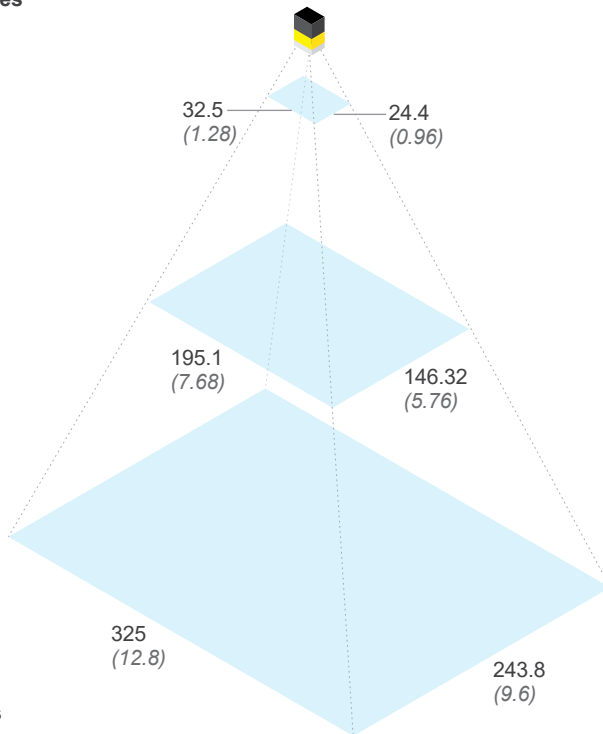

Focus distances

Minimum 50 mm (1.97) **Maximum** 2000 mm* (78.74)

HPIL and 16 mm lens

Minimum
100 (3.94)

Midpoint
300 (11.8)

Maximum
500 (19.69)

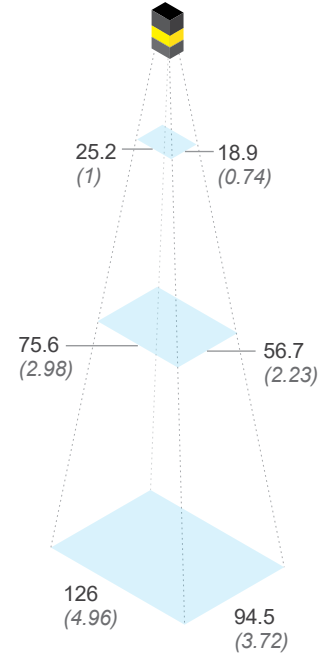

*Applications with working distances beyond 500 mm may result in an in-focus image but light uniformity/intensity will be significantly lower. External lighting is recommended for these scenarios.

Product IDs and Descriptions



IN-SIGHT 2802

	Product ID	Resolution	Configuration	Toolset	Light	Lens	Cover
	IS2802M-24520-SA	2MP	Mono Straight	EB/SS ¹ , All ViDi EL	RGBW Multi Torch	12 mm HSSL	Diffused
	IS2802M-24620-SA	2MP	Mono Straight	EB/SS, All ViDi EL	RGBW Multi Torch	16 mm HSSL	Diffused
	IS2802C-24520-SA	2MP	Color Straight	EB/SS, All ViDi EL	RGBW Multi Torch	12 mm HSSL	Diffused
	IS2802C-24620-SA	2MP	Color Straight	EB/SS, All ViDi EL	RGBW Multi Torch	16 mm HSSL	Diffused
	IS2802M-24521-SA	2MP	Mono Angled	EB/SS, All ViDi EL	RGBW Multi Torch	12 mm HSSL	Diffused
	IS2802M-24621-SA	2MP	Mono Angled	EB/SS, All ViDi EL	RGBW Multi Torch	16 mm HSSL	Diffused
	IS2802C-24521-SA	2MP	Color Angled	EB/SS, All ViDi EL	RGBW Multi Torch	12 mm HSSL	Diffused
	IS2802C-24621-SA	2MP	Color Angled	EB/SS, All ViDi EL	RGBW Multi Torch	16 mm HSSL	Diffused
	IS2802M-24520-SC	2MP	Mono Straight	EB/SS, EL Classify	RGBW Multi Torch	12 mm HSSL	Diffused
	IS2802M-24620-SC	2MP	Mono Straight	EB/SS, EL Classify	RGBW Multi Torch	16 mm HSSL	Diffused
	IS2802C-24520-SC	2MP	Color Straight	EB/SS, EL Classify	RGBW Multi Torch	12 mm HSSL	Diffused
	IS2802C-24620-SC	2MP	Color Straight	EB/SS, EL Classify	RGBW Multi Torch	16 mm HSSL	Diffused
	IS2802M-24521-SC	2MP	Mono Angled	EB/SS, EL Classify	RGBW Multi Torch	12 mm HSSL	Diffused
	IS2802M-24621-SC	2MP	Mono Angled	EB/SS, EL Classify	RGBW Multi Torch	16 mm HSSL	Diffused
	IS2802C-24521-SC	2MP	Color Angled	EB/SS, EL Classify	RGBW Multi Torch	12 mm HSSL	Diffused
	IS2802C-24621-SC	2MP	Color Angled	EB/SS, EL Classify	RGBW Multi Torch	16 mm HSSL	Diffused

1 EasyBuilder/Spreadsheet





This table includes only the most common product models. To get information on other available models, including angled configurations, please contact Cognex Sales at cognex.com/contact-sales.

IN-SIGHT 2802

	Product ID	Resolution	Configuration	Toolset	Light	Lens	Cover
	IS2802M-24520-SO	2MP	Mono Straight	EB/SS, EL Read	RGBW Multi Torch	12 mm HSLL	Diffused
	IS2802M-24620-SO	2MP	Mono Straight	EB/SS, EL Read	RGBW Multi Torch	16 mm HSLL	Diffused
	IS2802C-24520-SO	2MP	Color Straight	EB/SS, EL Read	RGBW Multi Torch	12 mm HSLL	Diffused
	IS2802C-24620-SO	2MP	Color Straight	EB/SS, EL Read	RGBW Multi Torch	16 mm HSLL	Diffused
	IS2802M-24521-SO	2MP	Mono Angled	EB/SS, EL Read	RGBW Multi Torch	12 mm HSLL	Diffused
	IS2802M-24621-SO	2MP	Mono Angled	EB/SS, EL Read	RGBW Multi Torch	16 mm HSLL	Diffused
	IS2802C-24521-SO	2MP	Color Angled	EB/SS, EL Read	RGBW Multi Torch	12 mm HSLL	Diffused
	IS2802C-24621-SO	2MP	Color Angled	EB/SS, EL Read	RGBW Multi Torch	16 mm HSLL	Diffused
	IS2802M-24520-SR	2MP	Mono Straight	EB/SS, Rule-based	RGBW Multi Torch	12 mm HSLL	Diffused
	IS2802M-24620-SR	2MP	Mono Straight	EB/SS, Rule-based	RGBW Multi Torch	16 mm HSLL	Diffused
	IS2802C-24520-SR	2MP	Color Straight	EB/SS, Rule-based	RGBW Multi Torch	12 mm HSLL	Diffused
	IS2802C-24620-SR	2MP	Color Straight	EB/SS, Rule-based	RGBW Multi Torch	16 mm HSLL	Diffused
	IS2802M-24521-SR	2MP	Mono Angled	EB/SS, Rule-based	RGBW Multi Torch	12 mm HSLL	Diffused
	IS2802M-24621-SR	2MP	Mono Angled	EB/SS, Rule-based	RGBW Multi Torch	16 mm HSLL	Diffused
	IS2802C-24521-SR	2MP	Color Angled	EB/SS, Rule-based	RGBW Multi Torch	12 mm HSLL	Diffused
	IS2802C-24621-SR	2MP	Color Angled	EB/SS, Rule-based	RGBW Multi Torch	16 mm HSLL	Diffused
	IS2802M-50000-SA	2MP	Mono Straight	EB/SS, All ViDi EL	C-Mount	N/A	N/A
	IS2802C-50000-SA	2MP	Color Straight	EB/SS, All ViDi EL	C-Mount	N/A	N/A
	IS2802M-50001-SA	2MP	Mono Angled	EB/SS, All ViDi EL	C-Mount	N/A	N/A
	IS2802C-50001-SA	2MP	Color Angled	EB/SS, All ViDi EL	C-Mount	N/A	N/A
	IS2802M-50000-SC	2MP	Mono Straight	EB/SS, EL Classify	C-Mount	N/A	N/A
	IS2802C-50000-SC	2MP	Color Straight	EB/SS, EL Classify	C-Mount	N/A	N/A
	IS2802M-50001-SC	2MP	Mono Angled	EB/SS, EL Classify	C-Mount	N/A	N/A
	IS2802C-50001-SC	2MP	Color Angled	EB/SS, EL Classify	C-Mount	N/A	N/A
	IS2802M-50000-SO	2MP	Mono Straight	EB/SS, EL Read	C-Mount	N/A	N/A
	IS2802C-50000-SO	2MP	Color Straight	EB/SS, EL Read	C-Mount	N/A	N/A
	IS2802M-50001-SO	2MP	Mono Angled	EB/SS, EL Read	C-Mount	N/A	N/A
	IS2802C-50001-SO	2MP	Color Angled	EB/SS, EL Read	C-Mount	N/A	N/A
	IS2802M-50000-SR	2MP	Mono Straight	EB/SS, Rule-based	C-Mount	N/A	N/A
	IS2802C-50000-SR	2MP	Color Straight	EB/SS, Rule-based	C-Mount	N/A	N/A
	IS2802M-50001-SR	2MP	Mono Angled	EB/SS, Rule-based	C-Mount	N/A	N/A
	IS2802C-50001-SR	2MP	Color Angled	EB/SS, Rule-based	C-Mount	N/A	N/A

This table includes only the most common product models. To get information on other available models, including angled configurations, please contact Cognex Sales at cognex.com/contact-sales.

IN-SIGHT 2800/2801



	Product ID	Resolution	Configuration	Toolset	Light	Lens	Cover
	IS2801M-24420-EC	1.6MP	Mono Straight	EasyBuilder, EL Classify	RGBW Multi Torch	8 mm HSSL	Diffused
	IS2801C-24420-EC	1.6MP	Color Straight	EasyBuilder, EL Classify	RGBW Multi Torch	8 mm HSSL	Diffused
	IS2801M-24520-EC	1.6MP	Mono Straight	EasyBuilder, EL Classify	RGBW Multi Torch	12 mm HSSL	Diffused
	IS2801C-24520-EC	1.6MP	Color Straight	EasyBuilder, EL Classify	RGBW Multi Torch	12 mm HSSL	Diffused
	IS2801M-24620-EC	1.6MP	Mono Straight	EasyBuilder, EL Classify	RGBW Multi Torch	16 mm HSSL	Diffused
	IS2801C-24620-EC	1.6MP	Color Straight	EasyBuilder, EL Classify	RGBW Multi Torch	16 mm HSSL	Diffused
	IS2801M-24420-EO	1.6MP	Mono Straight	EasyBuilder, EL Read	RGBW Multi Torch	8 mm HSSL	Diffused
	IS2801C-24420-EO	1.6MP	Color Straight	EasyBuilder, EL Read	RGBW Multi Torch	8 mm HSSL	Diffused
	IS2801M-24520-EO	1.6MP	Mono Straight	EasyBuilder, EL Read	RGBW Multi Torch	12 mm HSSL	Diffused
	IS2801C-24520-EO	1.6MP	Color Straight	EasyBuilder, EL Read	RGBW Multi Torch	12 mm HSSL	Diffused
	IS2801M-24620-EO	1.6MP	Mono Straight	EasyBuilder, EL Read	RGBW Multi Torch	16 mm HSSL	Diffused
	IS2801C-24620-EO	1.6MP	Color Straight	EasyBuilder, EL Read	RGBW Multi Torch	16 mm HSSL	Diffused
	IS2801M-24420-EA	1.6MP	Mono Straight	EasyBuilder, All ViDi EL	RGBW Multi Torch	8 mm HSSL	Diffused
	IS2801C-24420-EA	1.6MP	Color Straight	EasyBuilder, All ViDi EL	RGBW Multi Torch	8 mm HSSL	Diffused
	IS2801M-24520-EA	1.6MP	Mono Straight	EasyBuilder, All ViDi EL	RGBW Multi Torch	12 mm HSSL	Diffused
	IS2801C-24520-EA	1.6MP	Color Straight	EasyBuilder, All ViDi EL	RGBW Multi Torch	12 mm HSSL	Diffused
	IS2801M-24620-EA	1.6MP	Mono Straight	EasyBuilder, All ViDi EL	RGBW Multi Torch	16 mm HSSL	Diffused
	IS2801C-24620-EA	1.6MP	Color Straight	EasyBuilder, All ViDi EL	RGBW Multi Torch	16 mm HSSL	Diffused
	IS2801M-24520-ER	1.6MP	Mono Straight	EasyBuilder, Rule-based	RGBW Multi Torch	12 mm HSSL	Diffused
	IS2801M-24220-ER	1.6MP	Mono Straight	EasyBuilder, Rule-based	RGBW Multi Torch	12 mm	Diffused
IS2801M-24620-ER	1.6MP	Mono Straight	EasyBuilder, Rule-based	RGBW Multi Torch	16 mm HSSL	Diffused	
	IS2801M-42610-EC	1.6MP	Mono Straight	EasyBuilder, EL Classify	HPIL Red	16 mm HSSL	Clear
	IS2800M-42610-EC	SVGA	Mono Straight	EasyBuilder, EL Classify	HPIL Red	16 mm HSSL	Clear
	IS2800M-42610-ER	SVGA	Mono Straight	EasyBuilder, Rule-based	HPIL Red	16 mm HSSL	Clear
	IS2801M-32710-EC	1.6MP	Mono Straight	EasyBuilder, EL Classify	Mini Red	6.2 mm HSSL	Clear
	IS2800M-32710-EC	SVGA	Mono Straight	EasyBuilder, EL Classify	Mini Red	6.2 mm HSSL	Clear
	IS2800M-32710-ER	SVGA	Mono Straight	EasyBuilder, Rule-based	Mini Red	6.2 mm HSSL	Clear
	IS2801M-50000-EC	1.6MP	Mono Straight	EasyBuilder, EL Classify	C-Mount	N/A	N/A
	IS2801C-50000-EC	1.6MP	Color Straight	EasyBuilder, EL Classify	C-Mount	N/A	N/A
	IS2801M-50000-EO	1.6MP	Mono Straight	EasyBuilder, EL Read	C-Mount	N/A	N/A
	IS2801C-50000-EO	1.6MP	Color Straight	EasyBuilder, EL Read	C-Mount	N/A	N/A
	IS2801M-50000-EA	1.6MP	Mono Straight	EasyBuilder, All ViDi EL	C-Mount	N/A	N/A
	IS2801C-50000-EA	1.6MP	Color Straight	EasyBuilder, All ViDi EL	C-Mount	N/A	N/A

This table includes only the most common product models. To get information on other available models, including angled configurations, please contact Cognex Sales at cognex.com/contact-sales.



Components and accessories



Required



POWER AND I/O CABLES			
	Product ID	Length	Description
	CCB-PWRIO-05	5M	M12-12 to flying lead, straight
	CCB-PWRIO-10	10M	
	CCB-PWRIO-15	15M	
	CCB-PWRIO-05R	5M	M12-12 to flying lead, right-angled
	CCB-PWRIO-10R	10M	
	CCB-PWRIO-15R	15M	

MOUNTING BRACKETS		
	Product ID	Description
	DM100-UBRK-000	Universal mounting bracket
	DM100-PIVOTM-01	Pivot mounting bracket
	280-BKT-ADAPT	Flat surface mounting plate adapter for Multi Torch configuration

Optional



MULTI TORCH BANDPASS FILTERS		
	Product ID	Description
	280-TORCH-BP450	Blue bandpass filter (450 nm)
	280-TORCH-BP635	Red bandpass filter (635 nm)



MULTI TORCH FRONT COVERS*		
	Product ID	Description
	280-TORCH-COVPOL	Multi Torch cross polarized cover
	280-TORCH-COVCLR	Multi Torch clear cover
	280-TORCH-COVDIF	Multi Torch diffused cover
	280-TORCH-DOME	Multi Torch dome attachment

C-MOUNT		
	Product ID	Description
	DM280-CMNT-00	C-mount adapter
	DM280-CMNT-CVR	C-mount cover

*In-Sight 2800 comes with one front cover. Additional options or spare covers listed.

ETHERNET CABLES			
	Product ID	Length	Description
	CCB-84901-2001-02	2M	X-coded M12-8 to RJ-45, straight
	CCB-84901-2001-05	5M	
	CCB-84901-2001-10	10M	
	CCB-84901-2001-15	15M	
	CCB-84901-2001-30	30M	
	CCB-84901-2002-02	2M	X-coded M12-8 to RJ-45, right-angled
	CCB-84901-2002-05	5M	
	CCB-84901-2002-10	10M	
	CCB-84901-2RBT-02	2M	Robotic X-coded M12-8 to RJ-45, straight
	CCB-84901-2RBT-05	5M	
	CCB-84901-2RBT-10	10M	

MINI BANDPASS FILTERS		
	Product ID	Description
	DM150-BP470	Blue bandpass filter (6.2 mm lens only)
	DM150-BP635	Red bandpass filter (6.2 mm lens only)

MINI FRONT COVERS*		
	Product ID	Description
	DM280-CVR-62	Mini front cover (6.2 mm lens)—clear
	DM280-LENS-62CVR-F	Mini front cover (6.2 mm lens)—polarized
	DM260-LENS-16CVR	Mini HPIL front cover (16 mm lens)—clear
	DM260-LENS-16CVR-P	Mini HPIL front cover (16 mm lens)—half polarized
	DM260-LENS-16CVR-F	Mini HPIL front cover (16 mm lens)—fully polarized

Dimensions

In-Sight 2800 Series with Multi Torch

Straight configuration

[Download CAD files](#)

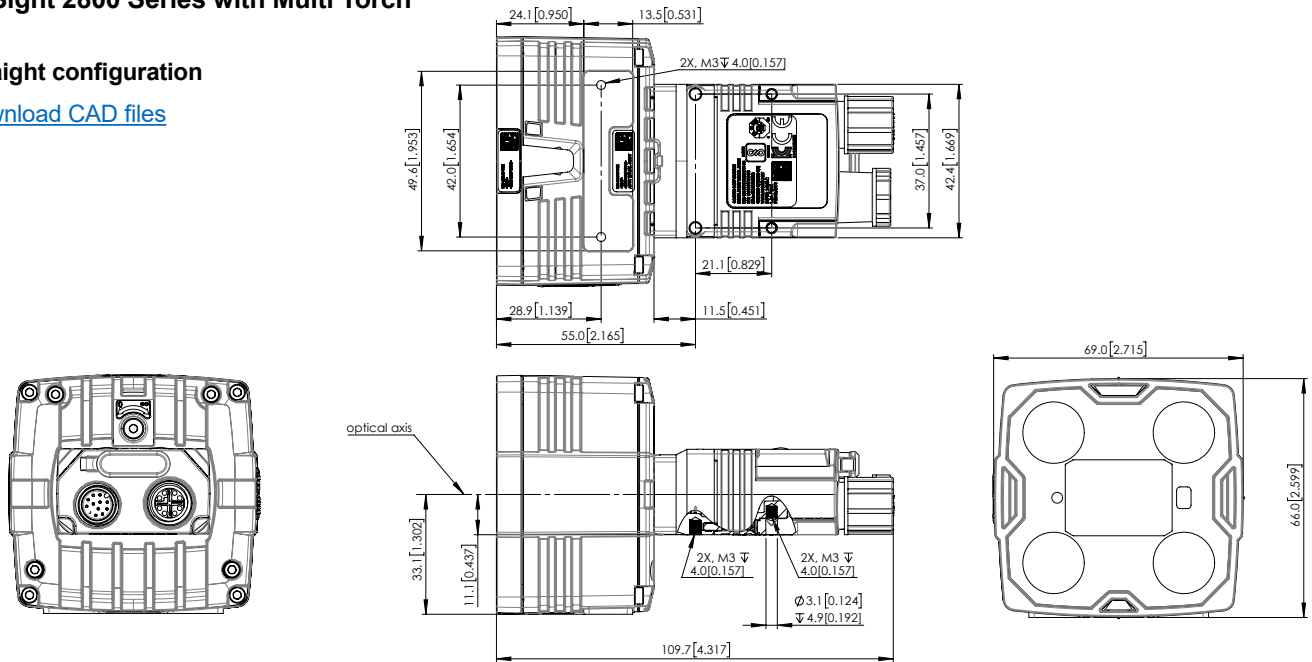

Right angle configuration

[Download CAD files](#)

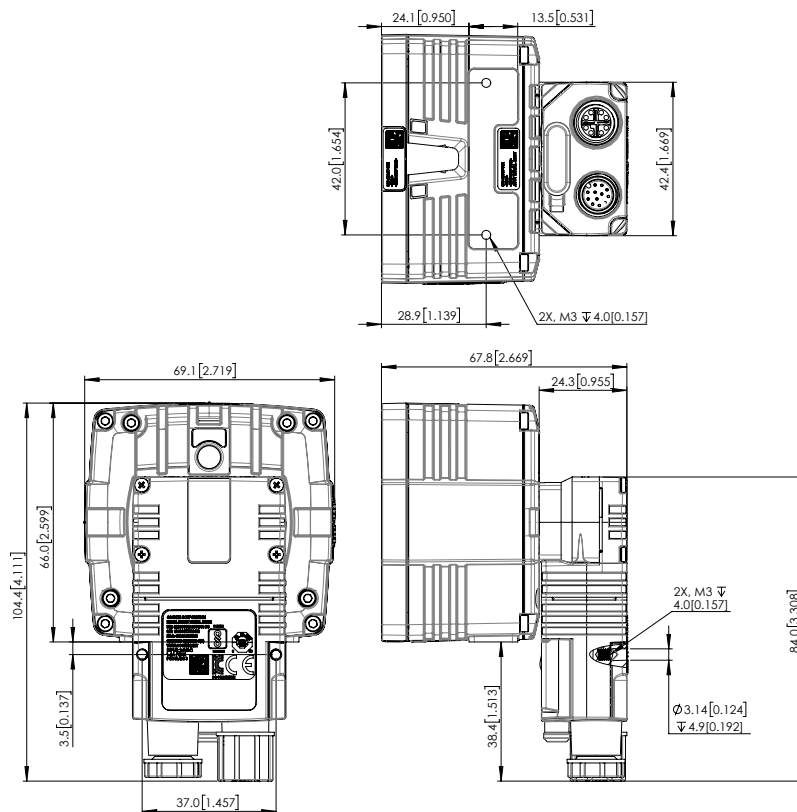

In-Sight 2800 Series with dome attachment

Straight configuration

[Download CAD files](#)

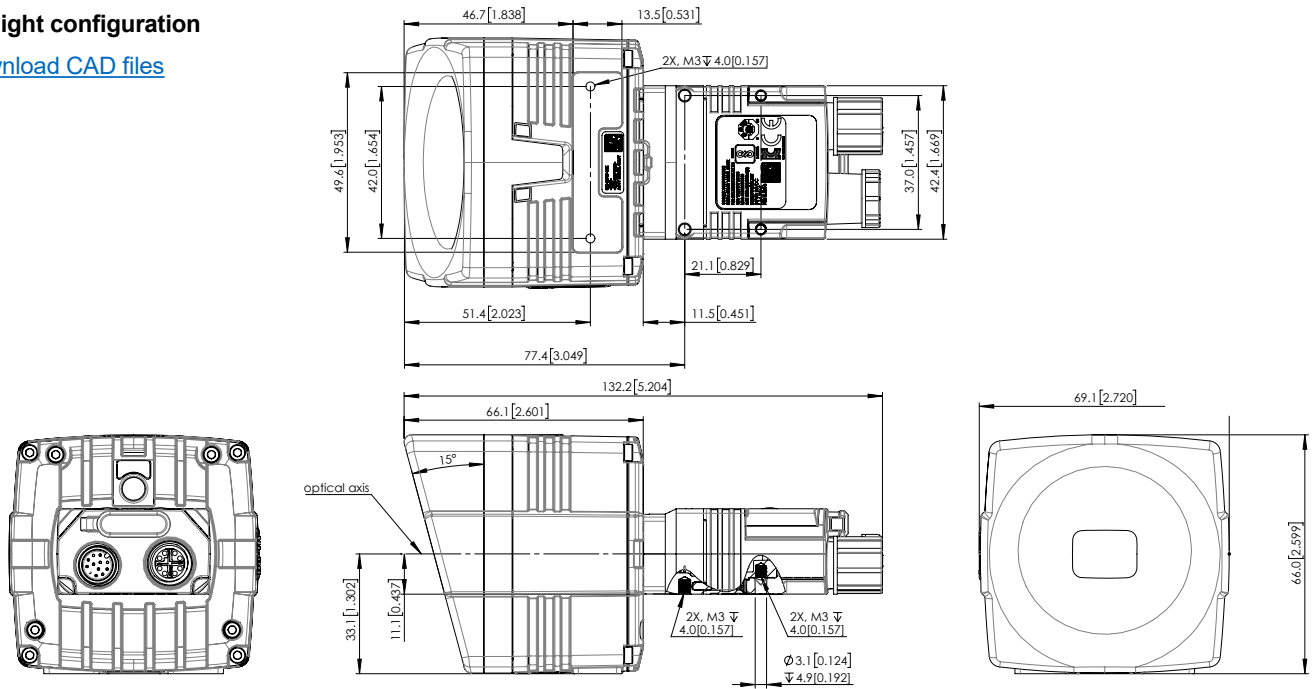

Right angle configuration

[Download CAD files](#)

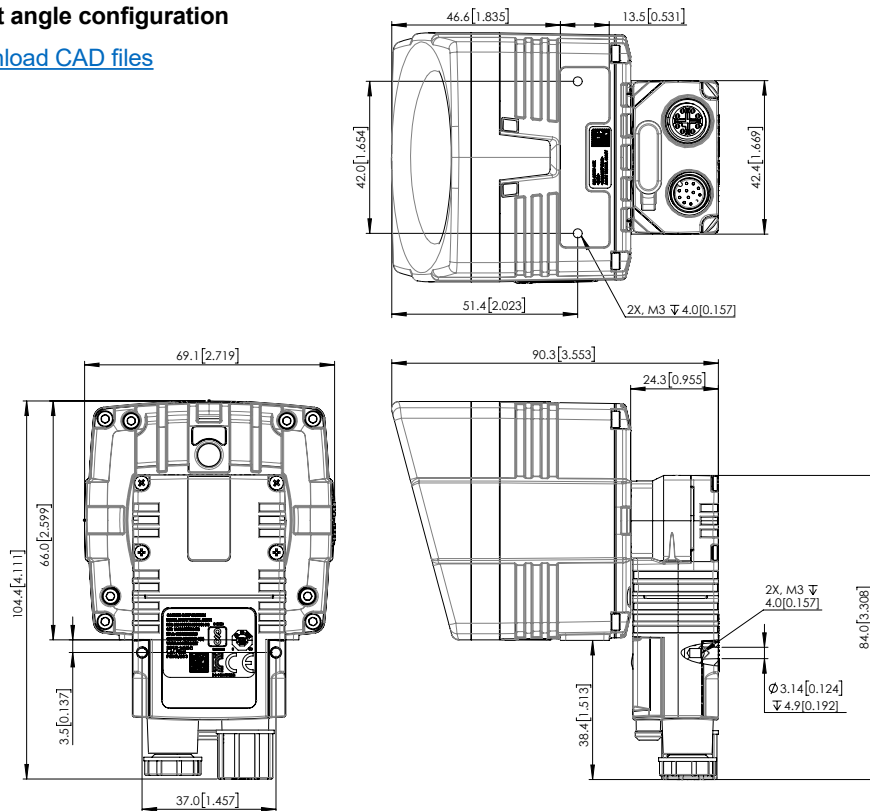

In-Sight 2800 Series Mini with 6.2 mm lens front cover

Straight configuration

[Download CAD files](#)

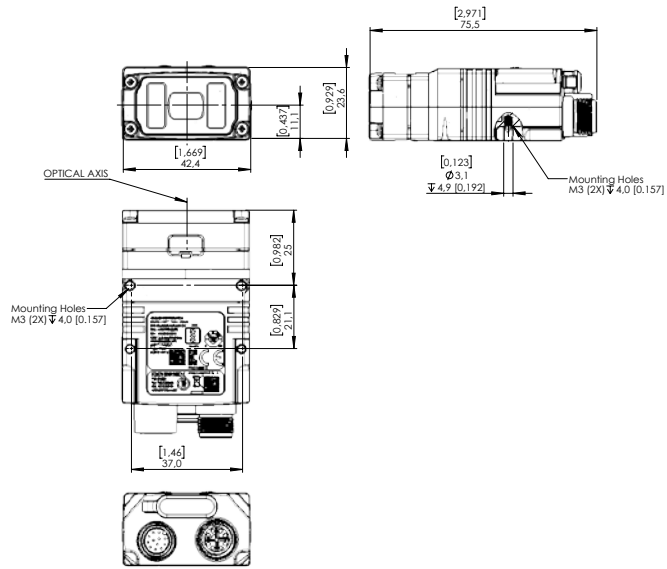

Right angle configuration

[Download CAD files](#)

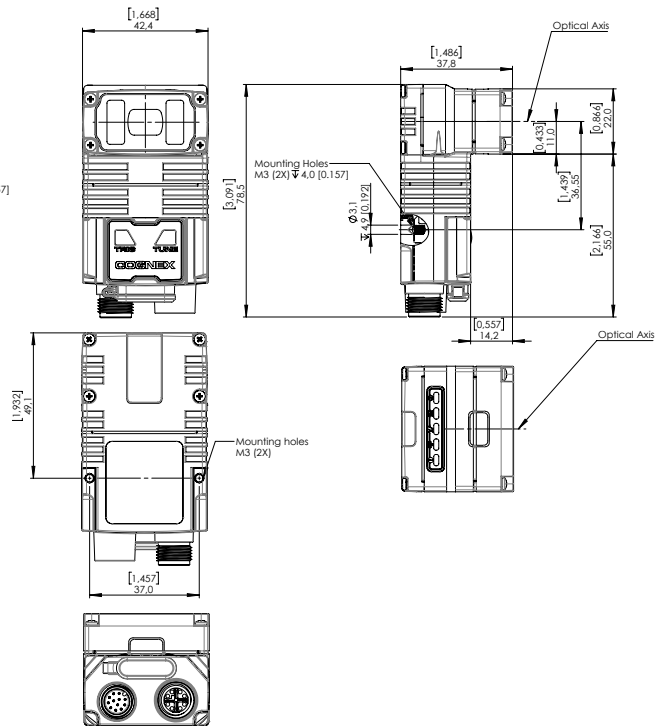

In-Sight 2800 Series Mini with 16 mm lens HPIL front cover

Straight configuration

[Download CAD files](#)

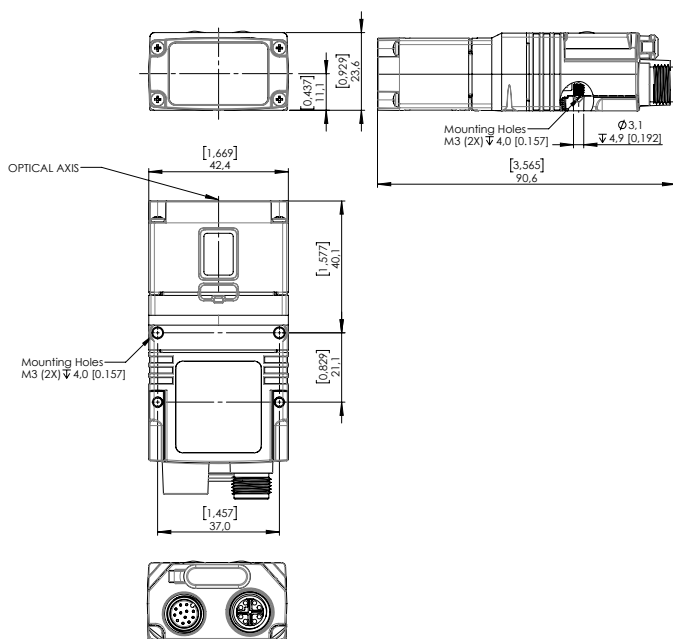

Right angle configuration

[Download CAD files](#)

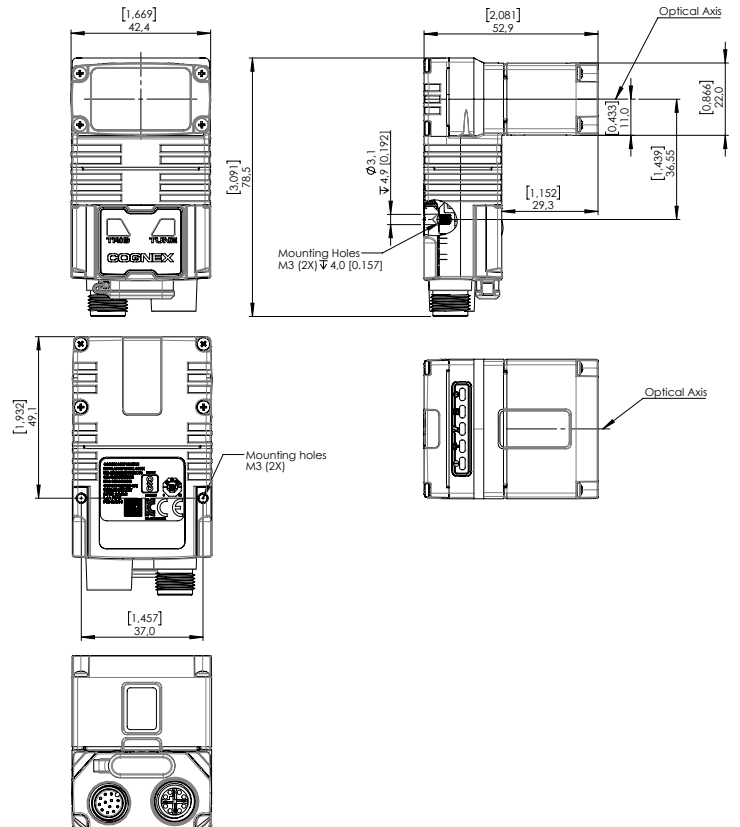

In-Sight 2800 Series with C-mount

[Download CAD files](#)

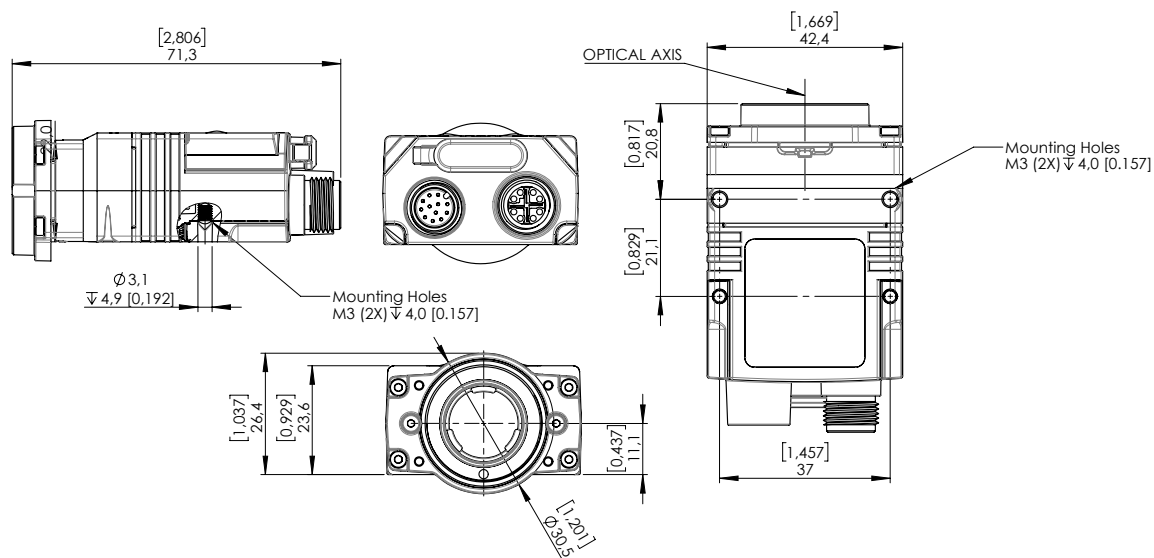

In-Sight 2800 Series with C-mount cover

[Download CAD files](#)

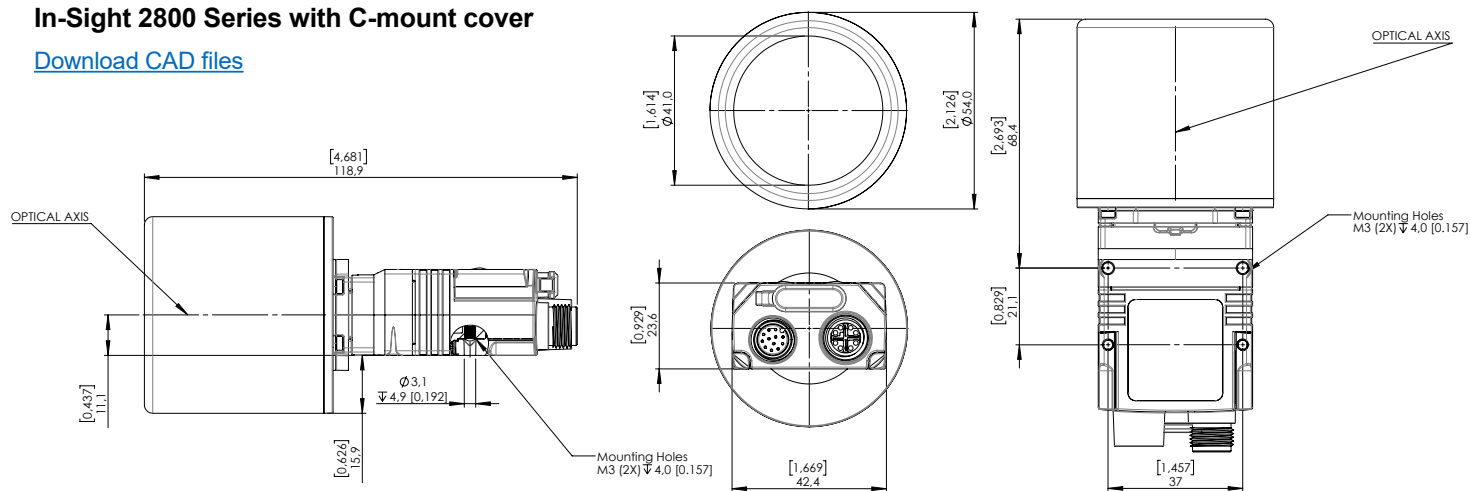

For more information, including software downloads, application examples, and product collateral, please visit:

cognex.com/in-sight-2800

COGNEX

Companies around the world rely on Cognex vision and barcode reading solutions to optimize quality, drive down costs and control traceability.

Corporate Headquarters One Vision Drive Natick, MA 01760 USA

Regional Sales Offices

Americas

North America +1 844 999 2469
Brazil +55 11 4210 3919
Mexico +800 733 4116

Europe

Austria +43 800 28 16 32
Belgium +32 289 370 75
Czechia +420 800 023 519
France +33 1 76 54 93 18
Germany +49 721 958 8052
Hungary +36 800 80291

Ireland +353 21 421 7500
Italy +39 02 3057 8196
Netherlands +31 207 941 398
Poland +48 717 121 086
Romania +40 741 041 272
Spain +34 93 299 28 14
Sweden +46 21 14 55 88
Switzerland +41 445 788 877
Turkey +90 216 900 1696
United Kingdom +44 121 29 65 163

Asia-Pacific

Australia +61 2 7202 6910
China +86 21 5875 1133

India +91 7305 040397
Indonesia +62 21 3076 1792
Japan +81 3 5977 5400
Korea +82 2 539 9047
Malaysia +6019 916 5532
New Zealand +64 9 802 0555
Philippines +63 2 8539 3990
Singapore +65 3158 3322
Taiwan +886 02 7703 2848
Thailand +66 6 3230 9998
Vietnam +84 98 2405167

© Copyright 2023, Cognex Corporation. All information in this document is subject to change without notice. All Rights Reserved. Cognex, In-Sight, and EasyBuilder are registered trademarks of Cognex Corporation. ViDi is a trademark of Cognex Corporation. All other trademarks are property of their respective owners. Lit. No. IS2800DS-09-2023

www.cognex.com